

UNIT

3

ALPHABET OF LINES

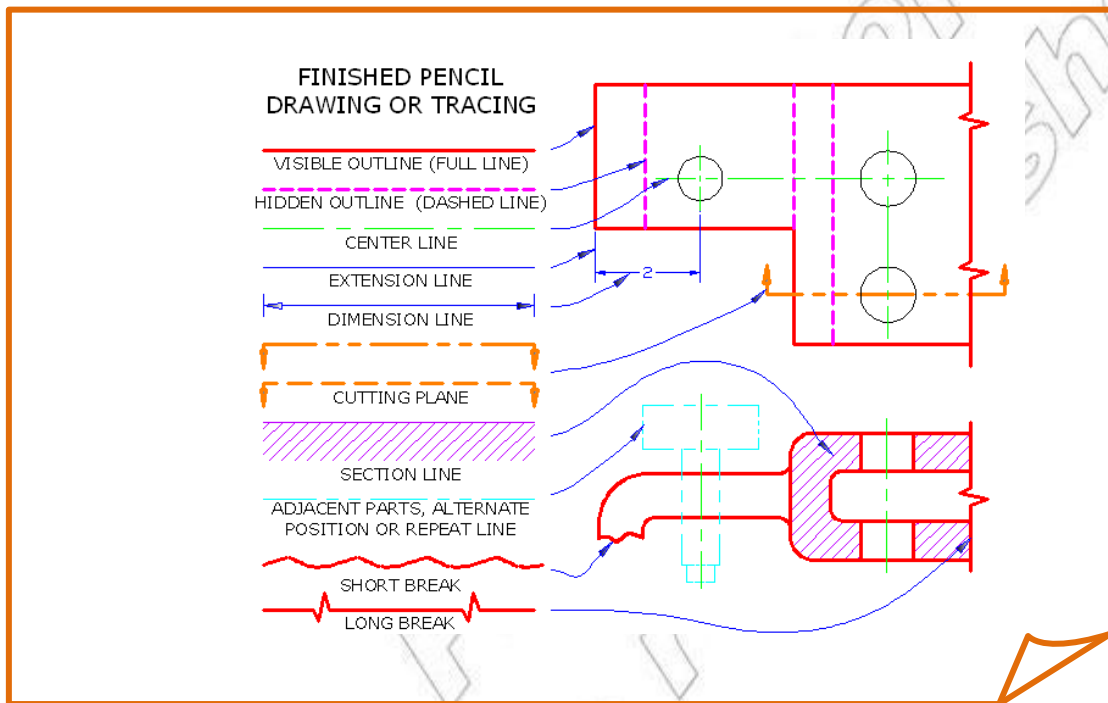

Learning competencies:

Up on completion of this unit you should be able to:

- ✓ Explain the types and purpose of different weight of lines in making drawings;
- ✓ Produce the lines with various line weights;
- ✓ Apply alphabet of lines for making proper working drawings.

3.1 Introduction

Have you ever seen a drawing proposal of a building or a machine? If you do what did you observe from the types of lines?

Lines of various forms and thickness are used as alphabets of the graphic language. If these lines are properly and systematically composed, they have the capacity to describe the shape of an object adequately.

It is beneficial to develop the capacity of discriminating each line in shape and thickness. The alphabet of lines may be categorized into three groups based on their weights or thickness.

The object line, the cutting plane line, and the short break lines should be drawn thick.

The center lines, dimension lines, extension lines, long-break lines, and phantom lines should be thin and the hidden should have an intermediate thickness between the thin and the thick lines.

In fact, thick lines are (0.5 to 0.8 mm) wide, thin lines between (0.03 to 0.5 mm) wide. The actual width each line is governed by the size, the style of the drawing and the smallest size to which it is to be reduced.

The description and illustrations shown in Fig. 3.1 would be of great help to understand the function of each line.

All the main line types are listed below:

- Visible
- Hidden
- Center
- Dimension
- Extension
- Cutting plane
- Section
- Break
- Phantom

| Types of Lines | Weight |
|-----------------------|--------|
| Object | Thick |
| Hidden | Medium |
| Center | Thin |
| Phantom | Thin |
| Extension & Dimension | Thin |
| Leader | Thin |
| Section | Thin |
| Cutting plane | Thick |
| Short break | Thick |
| Long break | Thin |

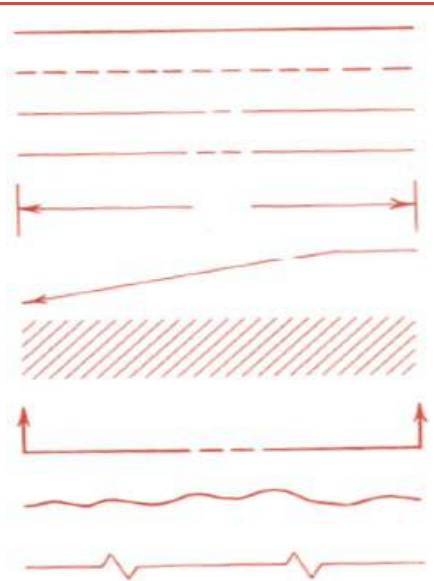

Fig.3.1 Types of Lines

1. Object lines: are dark, heavy solid lines used to show the out line and shape of an object and define features you can see in a particular view. These lines are the most prominent lines on drawings. The object line is also identified as visible line.

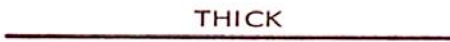

Fig. 3.2 Object lines

2. Hidden lines: are medium weight short dashed lines. They are used to show the out line of a feature that can not be seen in a particular view and help clarify a feature, but can be omitted if they clutter a drawing. The dashes of hidden lines should be drawn approximately 3 mm long with a space of 1.0mm left between each dash. However, the length may vary slightly to suit the size of the drawing.



Fig. 3.3 Hidden lines

3. Center lines: are thin lines composed of one long dash and one short dash spaced alternately. It is used to indicate axis of circles and symmetrical surfaces of an object. Depending up on the size of the drawing, the length of the long dash approximately ranges from 20-40mm. The short dash is about 3mm and the spacing between the long and short dashes is about 1.5mm.

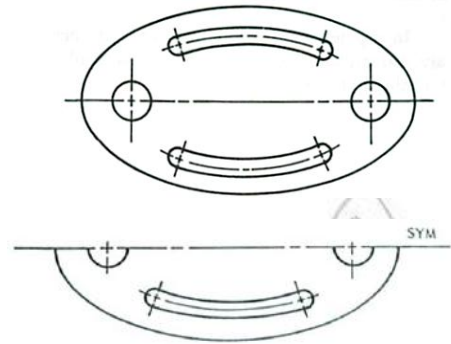

Fig. 3.4 Center lines

4. Dimension lines: are thin lines with arrowheads at its ends. It is used to Show the length, width, and height of the features of an object.



Fig. 3.5 Dimension line

5. Extension lines: are thin solid lines used to show the starting and stopping points of a dimension. Extension line is drawn approximately 1.5mm away from object line and is extended 3mm long beyond the outermost arrowhead.

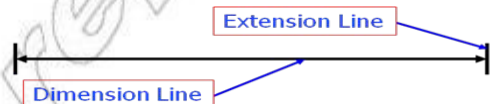

Fig. 3.6 Extension Line

6. Leader Lines: Thin lines, used to show the dimension of a feature or a note that is too large to be placed beside the feature itself.

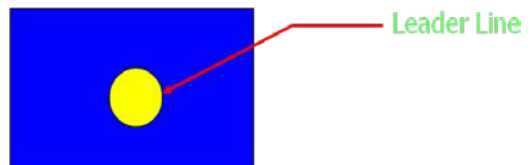

Fig. 3.7 Leader line

7. Cutting plane lines: are used to indicate the location of the cutting of cutting plane in the process of sectioning. Two forms of lines may be used. The first one is a dark line composed of one long and two short dashes spaced alternately. The long dashes are drawn approximately 20 to 40mm long or little more depending upon the size of the drawing. The short dashes are drawn approximately 3mm long, with a space of 1.5mm between each dash. The second form of cutting plane line is composed of equal dashes approximately 6mm long with spaces of 1.5mm between each dash. The ends of the cutting plane lines are bent 90° angle and are terminated by arrowhead to indicate the direction of sight.

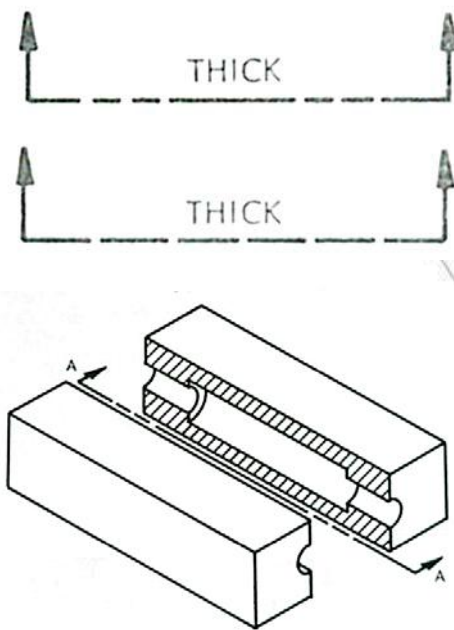

Fig. 3.8 Cutting plane lines

8. Section Lines: are used to indicate the cut surface of an object in sectional view. The section lines are usually drawn thin at 45 degree angle to produce a contrast with visible line. It should be equally spaced and proportional to the mass of the sectional surface.

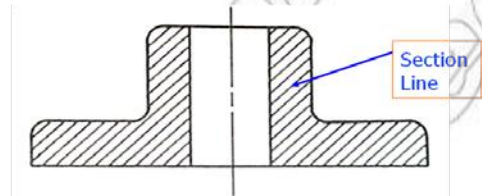

Fig. 3.9 Section lines

9. Break Lines: generally are used to break out sections for clarity or for shortening apart. Three types of lines with different line weights are used in break line. These are:

- Long breaks
- Short breaks
- Cylindrical breaks

Long Break Lines: are long and thin lines. It is used to show that the middle section of an object has been removed so it can be drawn on a smaller piece of paper.

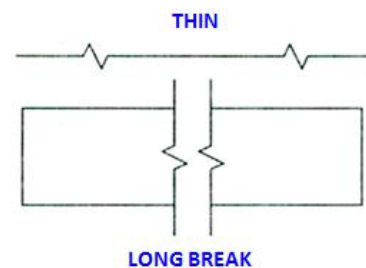

Fig.3.10 Long break lines

Short Break Lines: is thick wavy line. It is used to break the edge or surface of a part for clarity of a hidden surface.

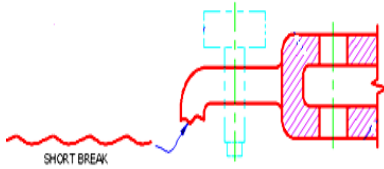

Fig.3.11 Short break lines

Cylindrical Break Lines: are thin lines. It is used to show round parts that are broken in half to better clarify the print or to reduce the length of the object.

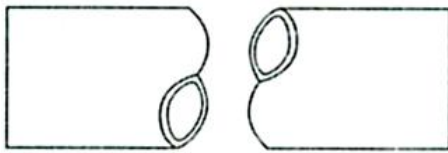

Fig.3.12 Cylindrical break lines

10. Phantom Lines: are thin lines composed of long dashes alternating with pairs of short dashes. The long dashes are drawn approximately 20-40mm long or a little more. The short dashes are drawn 3mm long with space of 1.5mm between each dash. Phantom lines are used for three purposes in drawings:

- ✓ To show the alternate position of machine part and lines of motion.
- ✓ To show the relationship of parts that fit together.
- ✓ To show repeated detail.

Alternate Position: Phantom lines can show where a part is moving to and from. It

eliminates the confusion of thinking there may be two parts instead of just one.

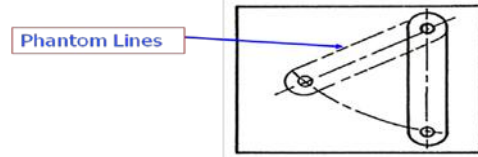

Fig. 3.13 Phantom line for alternate position

Relationship of Mating Parts: Phantom lines can also show how two or more parts go together without having to draw and dimension both parts.

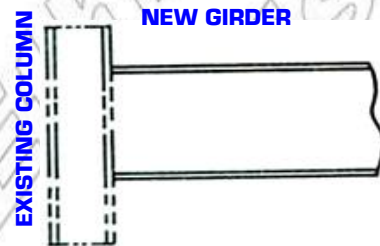

Fig.3.14 Phantom line for relationship of mating parts

Key terms

Column: A column in structural engineering is a vertical structural element that transmits, through compression, the weight of the structure above to other structural elements below.

Girder: is a large main supporting beam, commonly of steel or reinforced concrete that carries a heavy transverse (crosswise) load.

Repeated Detail: Phantom lines can show repeated detail of an object. This saves the drafter time and the company money.

Using phantom lines for repeated detail minimizes the drafter error.

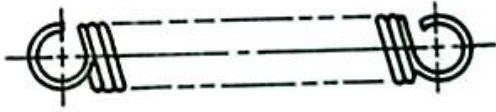

Fig.3.15 Phantom line for repeated detail

Activity 3.1

Search for a printed out floor plan, any architectural drawing or map drawing and find out the types of lines used in it.

UNIT SUMMARY

Lines in technical drawings are part of a specialized graphic language that is standardized throughout industry. Each type of line has a very precise symbolic meaning. Correct usage of this "alphabet of lines" is essential whether you use traditional drafting methods or CADD.

Line weights are a vital part of conventional technical graphics language. They are embodied to the extent of being defined in national and international standards. In manual drafting, different pen sizes allow the drafter to give different line weights to the lines in the drawing. Line types and line weights allow drawings to communicate information that would otherwise be very difficult to convey.

Therefore construction lines and guide lines are very light, easily erased lines used to block in the main layout. Visible lines are the edges or "outlines" of an object. They are drawn as solid lines with a thick/heavy weight. All other lines contrast with the visible lines by having either a thinner weight and/or a combination of dashes.

Exercise I

Match the following (write the letter of the correct definition on line to the left):

- | | |
|----------------------|--|
| _____ Object line | A. Used when it is not necessary to show all of a part. |
| _____ Hidden line | B. The lines which show the visible parts in a view. |
| _____ Center line | C. Used in combination with a cutting plane line to depict the inner structure of an object. |
| _____ Phantom line | D. Used to show the location of a cut for a sectional view or the direction from which a view is taken. |
| _____ Break line | E. Shows the course through which center travels. |
| _____ Extension line | F. A thin line that extends from the part or feature being dimensioned. |
| _____ Cutting plane | G. Used to indicate edges, intersections, etc., those are behind other features of the part. |
| _____ Section line | H. Used in conjunction with extension lines to indicate a linear distance. |
| _____ Dimension line | I. Shows alternate positions of parts and also the location of parts that are not integral parts of the item depicted. |

Exercise II

The following figure shows technical lines that describe a piece of machinery with a swinging arm. Identify the type of line represented by each number.

